



**1.39 inch AMOLED
without Touch Panel
SPECIFICATION**

MODEL NAME: LETBA400400N1

Date: 2017 / 03 / 30

Customer Signature		
Customer		
Approved Date	Approved By	Reviewed By

Contents

A. General Specification	5
1. Physical Specifications	5
2. FPC Pin Assignment.....	5
3. Absolute Maximum Ratings.....	6
B. DC Characteristics	7
1. Display DC Characteristics.....	7
2. Display Current Consumption.....	8
C. AC Characteristics	9
1. MIPI Interface Characteristics	9
2. Display RESET Timing Characteristics	11
Operating Sequence.....	13
D. Power IC Application Circuit	16
E. Display Scan Direction & Coordinate	16
F. Optical Specifications	22
G. Reliability Test Items	26
H. Packing	27
I. Outline Demension	28
J. Precaution	29



A. General Specification

1. Physical Specifications

	Item	Description	Remark
1	Screen Size (inch)	1.39"	
2	Display Mode	AMOLED	
3	Display Resolution	400x400	
4	Active Area (mm*mm)	35.4 (H)×35.4(V)	
5	Pixel Configuration	R.G.B	
6	Display Color (M)	16.7	
7	Brightness (nits)	300	
8	Interface	MIPI DSI	CMD Mode
9	Outline Dimension (mm*mm*mm)	38.6 (H) × 40.5(V) × 0.7(T)	cell+foam

2. FPC Pin Assignment

Main FPC Pin assignment — AMOLED Panel Input/Output Signal Interfac

FPCA recommended connector: AXE620124

Main board recommended connector: AXE520127

FPC	Pin_name	I/O	Description
1	ELVSS	P	AMOLED negative power supply
2	ELVDD	P	AMOLED positive power supply
3	ELVSS	P	AMOLED negative power supply
4	ELVDD	P	AMOLED positive power supply
5	ELVSS	P	AMOLED negative power supply
6	ELVDD	P	AMOLED positive power supply
7	VCI	P	Driver analog power supply
8	GND	P	Ground
9	VDDIO	P	Power supply for Interface system excep MIPI interface
10	DSI_D0N	I/O	MIPI negative data signal
11	GND	P	Ground
12	DSI_D0P	I/O	MIPI positive data signal
13	TE	O	Tearing effect output pin to synchronize MCU to frame writing.
14	GND	P	Ground
15	NC	-	No Connection
16	DSI_CLKN	I	MIPI negative clock signal
17	XRES	I	Device reset signal (0 : Enable ; 1: Disable)
18	DSI_CLKP	I	MIPI positive clock signal



19	SWIRE	O	SWIRE signal for PWR IC control
20	GND	P	Ground

Note: I = input ; O = output ; P = Power ; I/O = input / Output; NC= No Connection

3. Absolute Maximum Ratings

Item	Symbol	Min.	Max.	Unit	Remark
Digital Power Supply	VDDIO	-0.3	5.5	V	
Analog Power Supply	VCI	-0.3	5.5	V	
ELVDD power Supply	ELVDD	-	5.0	V	
ELVSS power Supply	ELVSS	-5.0	-	V	

Note : If the module exceeds the absolute maximum ratings, it may be damaged permanently.



B. DC Characteristics

1. Display DC Characteristics

Item	Symbol	Min.	Typ.	Max.	Unit	Remark	
Digital Power Supply	VDDIO	1.65	1.8	1.95	V	Note1	
Analog Power Supply	VCI	2.75	2.8	3.0	V	Note1	
ELVDD power Supply	ELVDD	4.55	4.60	4.65	V	Note1,2	
ELVSS power Supply	ELVSS	-2.35	-2.40	-2.45	V	Note1	
Input Signal Voltage	H Level	V_{IH}	0.8* VDDIO	-	VDDIO	V	Note1
	L Level	V_{IL}	0	-	0.2* VDDIO	V	
Output Signal Voltage	H Level	V_{OH}	0.8* VDDIO	-	VDDIO	V	Note1
	L Level	V_{OL}	0	-	0.2* VDDIO	V	Note1

Note 1: The operation is guaranteed under the recommended operating conditions only. The operation is not guaranteed if a quick voltage change occurs during the operation. To prevent the noise, a bypass capacitor must be inserted into the line closed to the power pin.

Note 2 : RT4723 Positive output voltage = $4.6V \pm 0.8\%$ at $-40^{\circ}C \leq T_a \leq +85^{\circ}C$



2. Display Current Consumption

Item	Symbol	Condition	Min.	Typ.	Max.	Unit	Remark	
Panel Power	P_{NL}	ELVDD:4.6V	--	--	140.7	mW	Note1,2,	
	I_{NL}	ELVSS:-2.4V	--	--	20.1	mA	Note1,2,	
IC	Normal	P_{VCI}	VCI : 2.8V	--	13.2	14.3	mW	Note2,
		I_{VCI}		--	4.7	5.1	mA	Note2,
		P_{VDDIO}	VDDIO :1.8V	--	4.0	5.6	mW	Note2,
		I_{VDDIO}		--	2.2	3.1	mA	Note2,
	Idle	P_{VCI}	VCI : 2.8V	--	5.8	6.4	mW	Note3,4
		I_{VCI}		--	2.1	2.3	mA	Note3,4
		P_{VDDIO}	VDDIO :1.8V	--	2.0	2.2	mW	Note3,
		I_{VDDIO}		--	1.1	1.2	mA	Note3,

Note 1: Based on L255 (300nits) full white pattern

Note 2: Based on black pattern. MIPI-DSI frame rate 60Hz command mode.

Note 3: Based on black pattern. MIPI-DSI frame rate 15Hz command mode.

Note 4: VCI Current must < 9mA at Idle mode.



C. AC Characteristics

1. MIPI Interface Characteristics

HS Data Transmission Burst

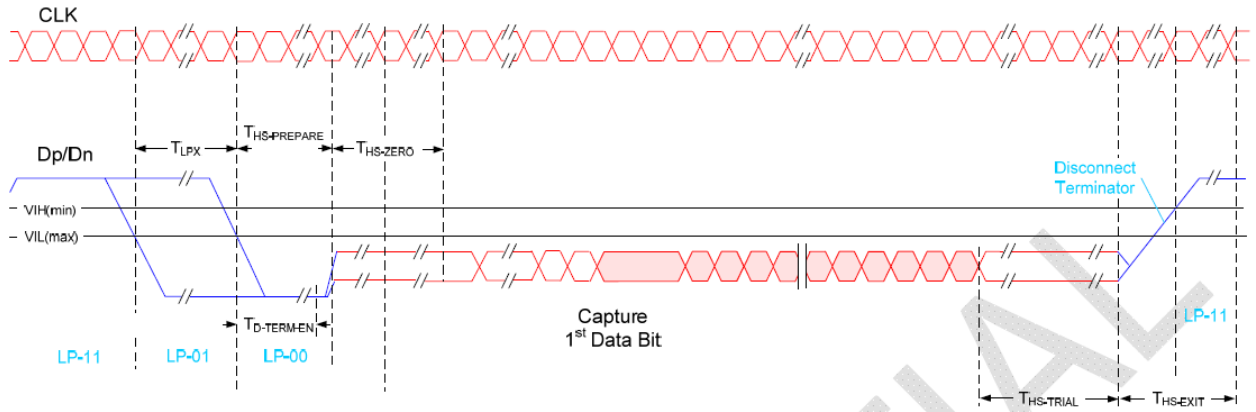

HS clock transmission

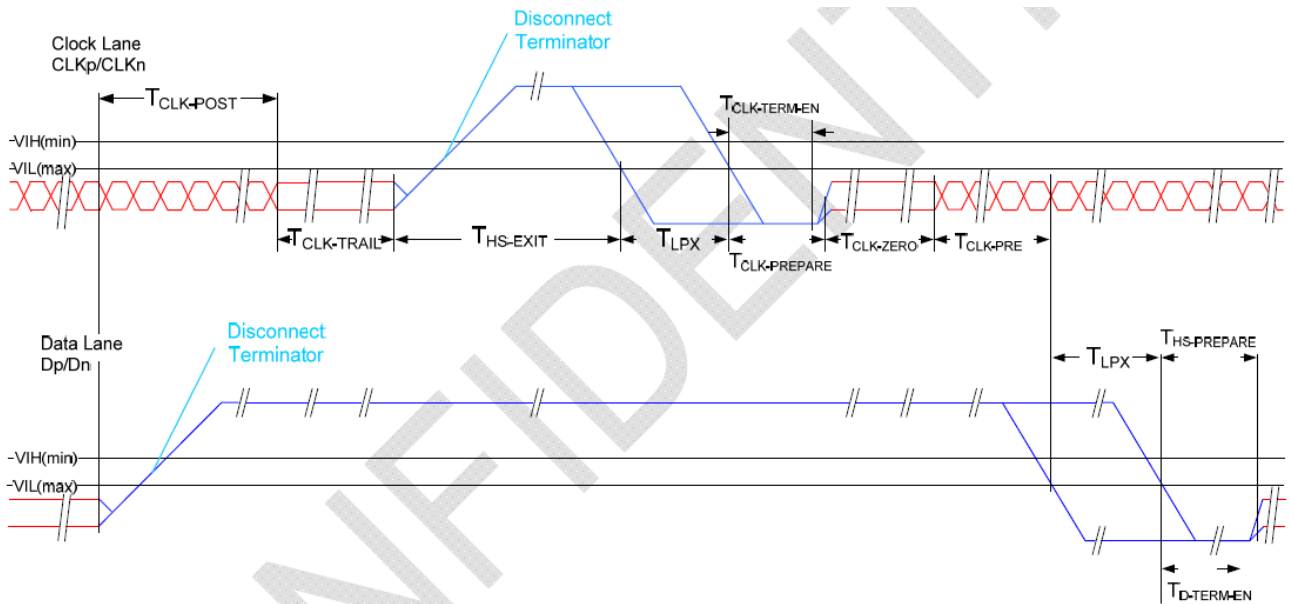

Turnaround Procedure

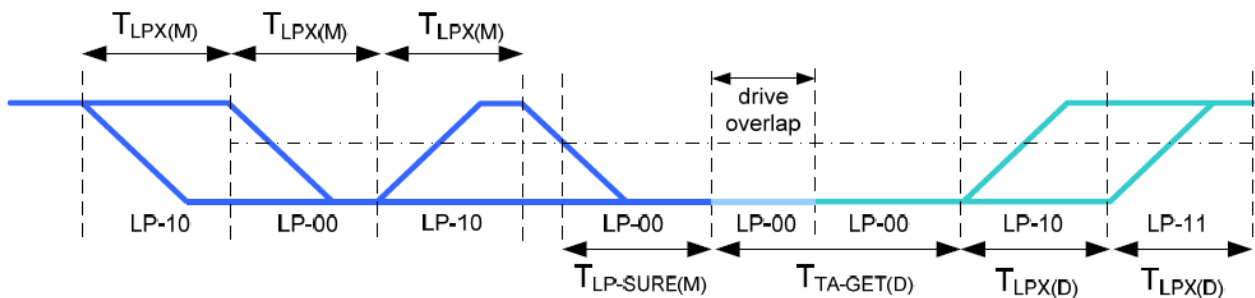

Bus turnaround (BAT) from MPU to display module timing

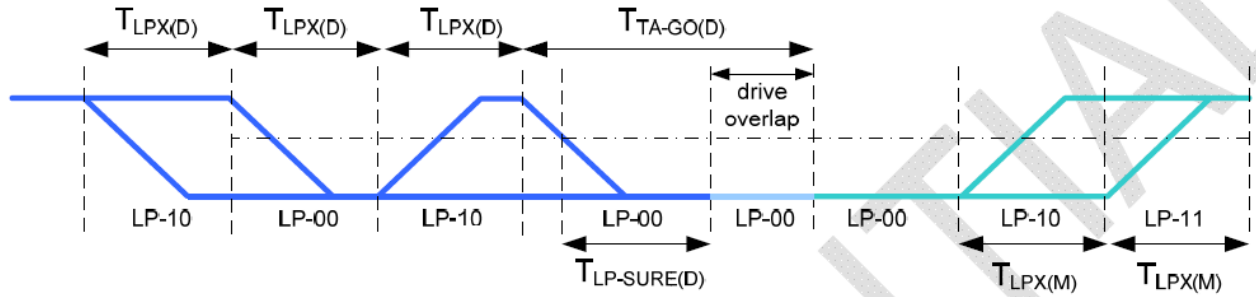

Timing Parameters

Symbol	Description	Min	Typ	Max	Unit
$T_{CLK-POST}$	Time that the transmitter continues to send HS clock after the last associated Data Lane has transitioned to LP Mode. Interval is defined as the period from the end of $T_{HS-TRAIL}$ to the beginning of $T_{CLK-TRAIL}$.	$60ns + 52*UI$			ns
$T_{CLK-TRAIL}$	Time that the transmitter drives the HS-0 state after the last payload clock bit of a HS transmission burst.	60			ns
$T_{HS-EXIT}$	Time that the transmitter drives LP-11 following a HS burst.	300			ns
$T_{CLK-TERM-EN}$	Time for the Clock Lane receiver to enable the HS line termination, time point when Dn crosses $V_{IL,MAX}$.	Time for Dn to reach $V_{TERM-EN}$		38	ns
$T_{CLK-PREPARE}$	Time that the transmitter drives the Clock Lane LP-00 Line state immediately before the HS-transmission.	38		95	ns
$T_{CLK-PRE}$	Time that the HS clock shall be driven by the transmitter prior to any associated Data Lane beginning the transition from LP to HS mode.	8			UI
$T_{CLK-PREPARE} + T_{CLK-ZERO}$	$T_{CLK-PREPARE}$ + time that the transmitter drives the HS-0 state prior to starting the Clock.	300			ns
$T_{D-TERM-EN}$	Time for the Data Lane receiver to enable the HS line termination, starting from the time point when Dn crosses $V_{IL,MAX}$.	Time for Dn to Reach $V_{TERM-EN}$		35 ns + $4*UI$	
$T_{HS-PREPARE}$	Time that the transmitter drives the Data Lane LP-00 Line state immediately before	$40ns + 4*UI$		$85 ns + 6*UI$	ns



	the HS-0 Line state starting the HS transmission				
$T_{HS-PREPARE} + T_{HS-ZERO}$	$T_{HS-PREPARE}$ + time that the transmitter drives the HS-0 state prior to transmitting the Sync sequence.	$145ns + 10*UI$			ns
$T_{HS-TRAIL}$	Time that the transmitter drives the flipped differential state after last payload data bit of a HS transmission burst	$60ns + 4*UI$			ns
$T_{LPX(M)}$	Transmitted length of any Low-Power state period of MCU to display module	50		150	ns
$T_{TA-SURE(M)}$	Time that the display module waits after the LP-10 state before transmitting the Bridge state (LP-00) during a Link Turnaround.	$T_{LPX(M)}$		$2*T_{LPX(M)}$	ns
$T_{LPX(D)}$	Transmitted length of any Low-Power state period of display module to MCU	50		150	ns
$T_{TA-GET(D)}$	Time that the display module drives the Bridge state (LP-00) after accepting control during a Link Turnaround.		$5*T_{LPX(D)}$		ns
$T_{TA-GO(D)}$	Time that the display module drives the Bridge state (LP-00) before releasing control during a Link Turnaround.		$4*T_{LPX(D)}$		ns
$T_{TA-SURE(D)}$	Time that the MPU waits after the LP-10 state before transmitting the Bridge state (LP-00) during a Link Turnaround.	$T_{LPX(D)}$		$2*T_{LPX(D)}$	ns

2. Display RESET Timing Characteristics

Reset input timing

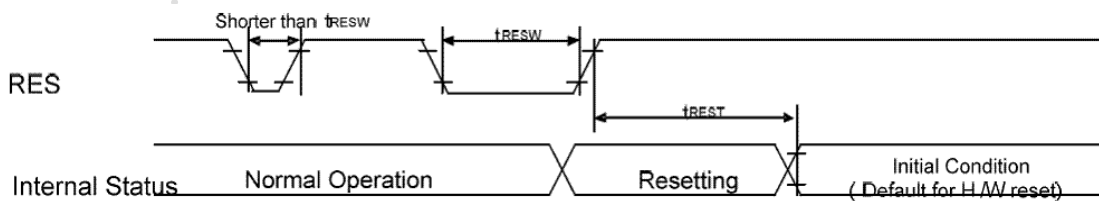

Timing Parameters

Symbol	Parameter	Related Pins	MIN	TYP	MAX	Note	Unit
t_{RESW}	*1) Reset low pulse width	RESX	10	-	-	-	μs
t_{REST}	*2) Reset complete time	-	-	-	5	When reset applied during Sleep in mode	ms
		-	-	-	120	When reset applied during Sleep out mode	ms

Note 1. Spike due to an electrostatic discharge on RESX line does not cause irregular system reset according to the table below.



RESX Pulse	Action
Shorter than 5 μ s	Invalid Reset
Longer than 15 μ s	Valid Reset
Between 5 μ s and 15 μ s	Reset Initialigation Precedure

Note 2. During the resetting period, the display will be blanked (The display is entering blanking sequence, which maximum time is 120 ms, when Reset Starts in Sleep Out –mode. The display remains the blank state in Sleep In –mode) and then return to Default condition for H/W reset.

Note 3. During Reset Complete Time, data in OTP will be latched to internal register during this period. This loading is done every time when there is H/W reset complete time (tREST) within 5ms after a rising edge of RESX.

Note 4. Spike Rejection also applies during a valid reset pulse as shown below:

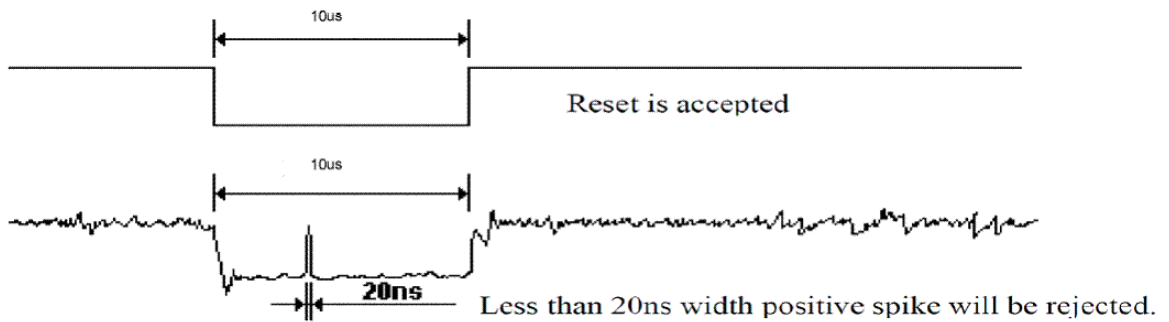

Note 5. It is necessary to wait 5msec after releasing RESX before sending commands. Also Sleep Out command cannot be sent for 120msec.

TE Timing Characteristics

Mode 1, the tearing effect output signal consist of V-sync information only:

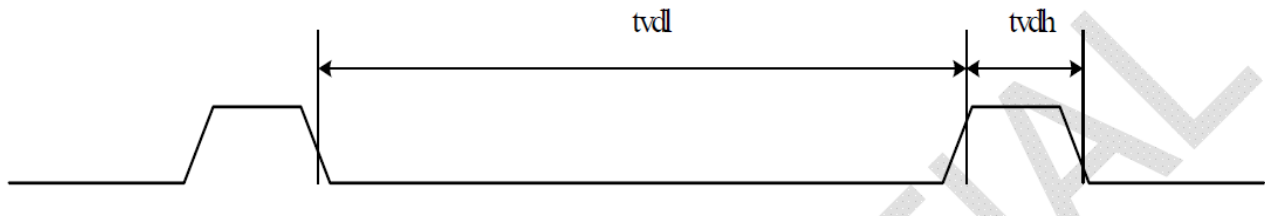

tvdh = The display is not updated from the frame memory

tvdl = The display is updated from the frame memory

MIPI Initial CMD Flow

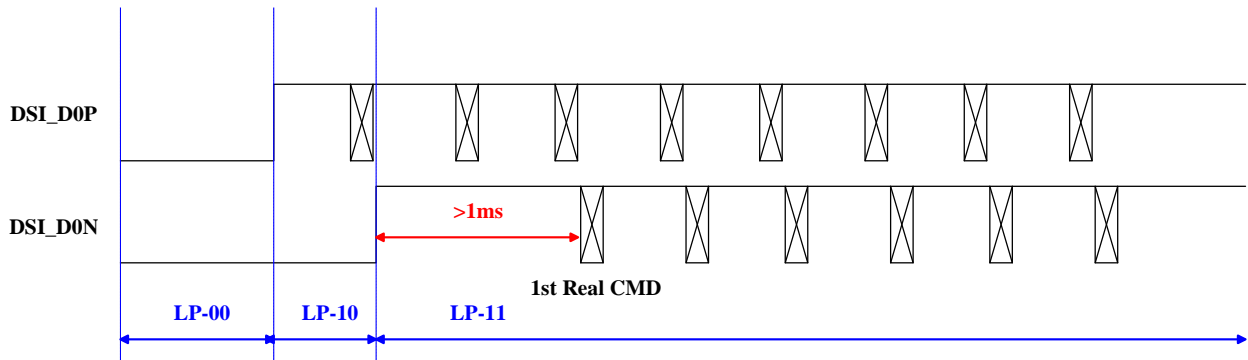

Operating Sequence

Power Structure

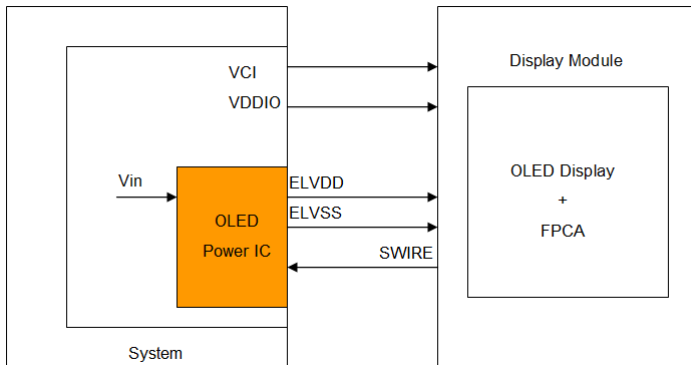

Display Power on/off Sequence

Power on sequence

Power On sequence

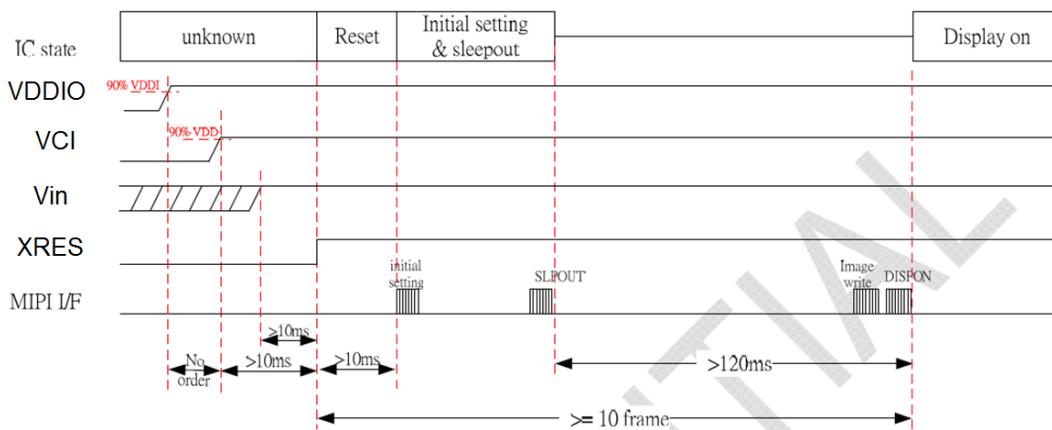

Power off sequence

Power Off sequence

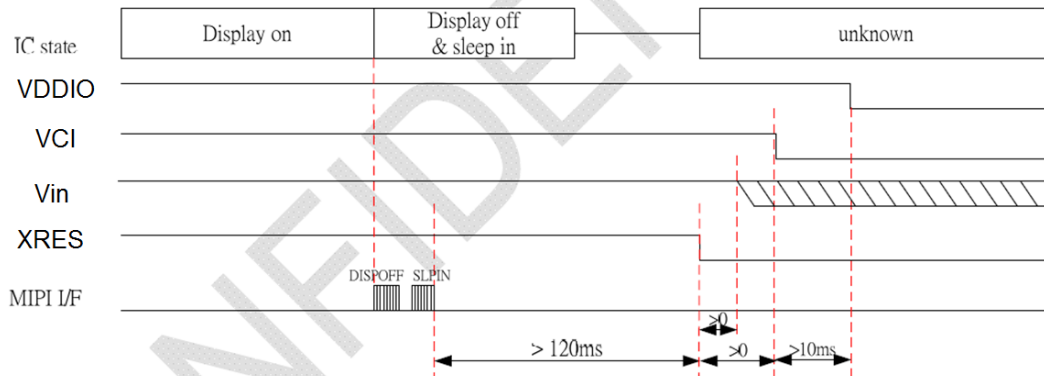

Display Initial Setting

Recommended Power on Initial Sequence								
Step	Instruction/Parameters	Delay time	R/W	MIPI Data Type	Address		Data hex.	Description
					MIPI	Others		
1	Turn on V _{CI}							VCI=2.8V
2	Turn on V _{DDIO}							VDDIO=1.8V
3	Delay	no limit						
4	REST pin low	20us						
5	REST pin high							
6	Delay	5 ms						
7			W	0x15	FE	FE00	05	
8			W	0x15	05	0580	00	
9			W	0x15	FE	FE00	07	
10			W	0x15	07	07A0	6D	
11			W	0x15	FE	FE00	0A	
12			W	0x15	1C	1CD0	1B	
13			W	0x15	FE	FE00	00	
14			W	0x15	35	3500	00	
15	Sleep out		W	0x05	11	1100	00	
16	Turn on peripheral packet			0x32				Video Turn On
17	Delay	300 ms						
18	Display on		W	0x05	29	2900	00	
Recommended Power off Mode Sequence								
Step	Instruction/Parameters	Delay time	R/W	MIPI Data Type	Address		Data hex.	Description
					MIPI	Others		
1	Display Off		W	0x05	28	2800	00	
2	Sleep in		W	0x05	10	1000	00	
3	delay	120ms						
4	Power off							



Idle mode Flow

(1) Normal to Idle

Recommended Idle Initial Sequence								
Step	Instruction/Parameters	Delay time	R/W	MIPI Data Type	Address		Data hex.	Description
					MIPI	Others		
1	Enter Idle mode		W	0x05	39	3900	00	Idle mode 15HZ

(2) Idle to Normal

Recommended Power on Initial Sequence								
Step	Instruction/Parameters	Delay time	R/W	MIPI Data Type	Address		Data hex.	Description
					MIPI	Others		
1	Idle mode Off		W	0x05	38	3800	00	Normal mode 60HZ

Brightness Control

Recommended Brightness Control							
Instruction/Parameters	Delay time	R/W	MIPI Data Type	Address		Data hex.	Description
				MIPI	Others		
Brightness control		W	0x05	51	5100	Value	Value form 0~255(FF)



D. Power IC Application Circuit

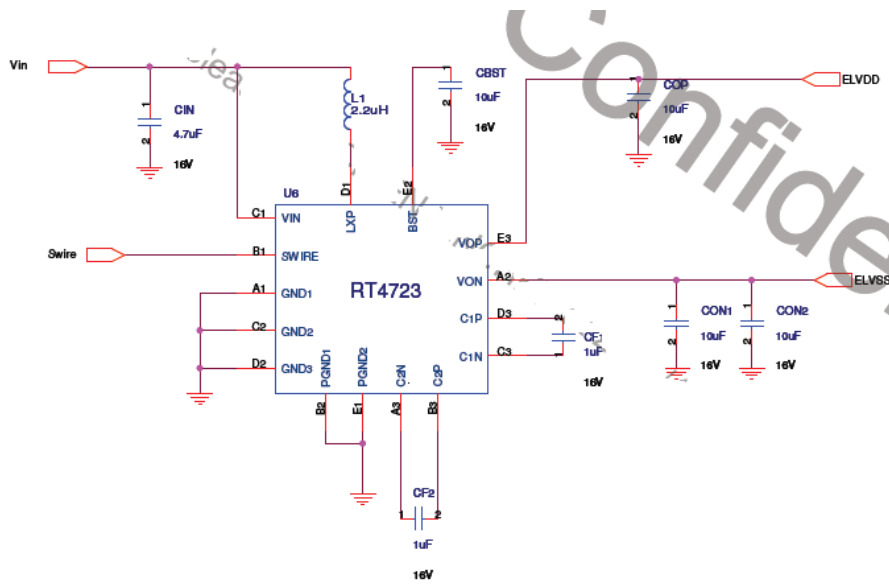

1. Inteltronic 1.39" panel has to be used with power IC RT4723, **Richtek**.
Inteltronic don't suggest use other power IC instead of RT4723, since they don't be qualified by
2. Recommend power inductor L1
 - a. [TOKO – DFE252010C (1269AS-H-2R2N=P2)] 2.2uH 2.5mm*2.0mm*1.0moldsunm
 - b. [Taiyo – MDKK2020T2R2MM] 2.2uH 2.0mm*2.0mm*1.0mm

E. Display Scan Direction & Coordinate

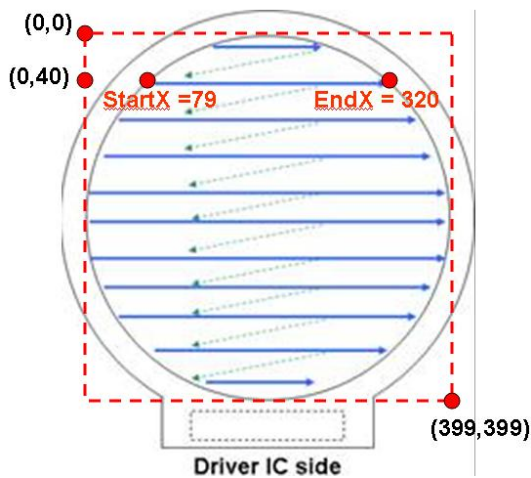

Panel Start Point = (0 , 0)
 Panel End Point = (399 , 399)
 Each Line = (Start x , y) ~~ (End x , y)



Coordinate

Y	start_X	end_X	Total	Y	start_X	end_X	Total	Y	start_X	end_X	Total
0	187	212	26	30	94	305	212	60	57	342	286
1	176	223	48	31	92	307	216	61	56	343	288
2	169	230	62	32	91	308	218	62	55	344	290
3	163	236	74	33	89	310	222	63	54	345	292
4	158	241	84	34	88	311	224	64	53	346	294
5	154	245	92	35	86	313	228	65	52	347	296
6	150	249	100	36	85	314	230	66	51	348	298
7	146	253	108	37	84	315	232	67	50	349	300
8	143	256	114	38	82	317	236	68	49	350	302
9	139	260	122	39	81	318	238	69	49	350	302
10	136	263	128	40	79	320	242	70	48	351	304
11	133	266	134	41	78	321	244	71	47	352	306
12	131	268	138	42	77	322	246	72	46	353	308
13	128	271	144	43	76	323	248	73	45	354	310
14	125	274	150	44	74	325	252	74	44	355	312
15	123	276	154	45	73	326	254	75	44	355	312
16	121	278	158	46	72	327	256	76	43	356	314
17	118	281	164	47	71	328	258	77	42	357	316
18	116	283	168	48	70	329	260	78	41	358	318
19	114	285	172	49	68	331	264	79	40	359	320
20	112	287	176	50	67	332	266	80	40	359	320
21	110	289	180	51	66	333	268	81	39	360	322
22	108	291	184	52	65	334	270	82	38	361	324
23	106	293	188	53	64	335	272	83	38	361	324
24	104	295	192	54	63	336	274	84	37	362	326
25	102	297	196	55	62	337	276	85	36	363	328
26	101	298	198	56	61	338	278	86	35	364	330
27	99	300	202	57	60	339	280	87	35	364	330
28	97	302	206	58	59	340	282	88	34	365	332
29	96	303	208	59	58	341	284	89	33	366	334



Y	start_X	end_X	Total	Y	start_X	end_X	Total	Y	start_X	end_X	Total
90	33	366	334	120	17	382	366	150	6	393	388
91	32	367	336	121	16	383	368	151	6	393	388
92	31	368	338	122	16	383	368	152	6	393	388
93	31	368	338	123	15	384	370	153	6	393	388
94	30	369	340	124	15	384	370	154	5	394	390
95	30	369	340	125	14	385	372	155	5	394	390
96	29	370	342	126	14	385	372	156	5	394	390
97	28	371	344	127	14	385	372	157	5	394	390
98	28	371	344	128	13	386	374	158	4	395	392
99	27	372	346	129	13	386	374	159	4	395	392
100	27	372	346	130	13	386	374	160	4	395	392
101	26	373	348	131	12	387	376	161	4	395	392
102	25	374	350	132	12	387	376	162	4	395	392
103	25	374	350	133	11	388	378	163	3	396	394
104	24	375	352	134	11	388	378	164	3	396	394
105	24	375	352	135	11	388	378	165	3	396	394
106	23	376	354	136	10	389	380	166	3	396	394
107	23	376	354	137	10	389	380	167	3	396	394
108	22	377	356	138	10	389	380	168	3	396	394
109	22	377	356	139	9	390	382	169	2	397	396
110	21	378	358	140	9	390	382	170	2	397	396
111	21	378	358	141	9	390	382	171	2	397	396
112	20	379	360	142	9	390	382	172	2	397	396
113	20	379	360	143	8	391	384	173	2	397	396
114	19	380	362	144	8	391	384	174	2	397	396
115	19	380	362	145	8	391	384	175	2	397	396
116	18	381	364	146	7	392	386	176	1	398	398
117	18	381	364	147	7	392	386	177	1	398	398
118	17	382	366	148	7	392	386	178	1	398	398
119	17	382	366	149	7	392	386	179	1	398	398



Y	start_X	end_X	Total	Y	start_X	end_X	Total	Y	start_X	end_X	Total
180	1	398	398	210	0	399	400	240	4	395	392
181	1	398	398	211	0	399	400	241	4	395	392
182	1	398	398	212	0	399	400	242	5	394	390
183	1	398	398	213	1	398	398	243	5	394	390
184	1	398	398	214	1	398	398	244	5	394	390
185	1	398	398	215	1	398	398	245	5	394	390
186	1	398	398	216	1	398	398	246	6	393	388
187	0	399	400	217	1	398	398	247	6	393	388
188	0	399	400	218	1	398	398	248	6	393	388
189	0	399	400	219	1	398	398	249	6	393	388
190	0	399	400	220	1	398	398	250	7	392	386
191	0	399	400	221	1	398	398	251	7	392	386
192	0	399	400	222	1	398	398	252	7	392	386
193	0	399	400	223	1	398	398	253	7	392	386
194	0	399	400	224	2	397	396	254	8	391	384
195	0	399	400	225	2	397	396	255	8	391	384
196	0	399	400	226	2	397	396	256	8	391	384
197	0	399	400	227	2	397	396	257	9	390	382
198	0	399	400	228	2	397	396	258	9	390	382
199	0	399	400	229	2	397	396	259	9	390	382
200	0	399	400	230	2	397	396	260	9	390	382
201	0	399	400	231	3	396	394	261	10	389	380
202	0	399	400	232	3	396	394	262	10	389	380
203	0	399	400	233	3	396	394	263	10	389	380
204	0	399	400	234	3	396	394	264	11	388	378
205	0	399	400	235	3	396	394	265	11	388	378
206	0	399	400	236	3	396	394	266	11	388	378
207	0	399	400	237	4	395	392	267	12	387	376
208	0	399	400	238	4	395	392	268	12	387	376
209	0	399	400	239	4	395	392	269	13	386	374



Y	start_X	end_X	Total	Y	start_X	end_X	Total	Y	start_X	end_X	Total
270	13	386	374	300	27	372	346	330	49	350	302
271	13	386	374	301	28	371	344	331	49	350	302
272	14	385	372	302	28	371	344	332	50	349	300
273	14	385	372	303	29	370	342	333	51	348	298
274	14	385	372	304	30	369	340	334	52	347	296
275	15	384	370	305	30	369	340	335	53	346	294
276	15	384	370	306	31	368	338	336	54	345	292
277	16	383	368	307	31	368	338	337	55	344	290
278	16	383	368	308	32	367	336	338	56	343	288
279	17	382	366	309	33	366	334	339	57	342	286
280	17	382	366	310	33	366	334	340	58	341	284
281	17	382	366	311	34	365	332	341	59	340	282
282	18	381	364	312	35	364	330	342	60	339	280
283	18	381	364	313	35	364	330	343	61	338	278
284	19	380	362	314	36	363	328	344	62	337	276
285	19	380	362	315	37	362	326	345	63	336	274
286	20	379	360	316	38	361	324	346	64	335	272
287	20	379	360	317	38	361	324	347	65	334	270
288	21	378	358	318	39	360	322	348	66	333	268
289	21	378	358	319	40	359	320	349	67	332	266
290	22	377	356	320	40	359	320	350	68	331	264
291	22	377	356	321	41	358	318	351	70	329	260
292	23	376	354	322	42	357	316	352	71	328	258
293	23	376	354	323	43	356	314	353	72	327	256
294	24	375	352	324	44	355	312	354	73	326	254
295	24	375	352	325	44	355	312	355	74	325	252
296	25	374	350	326	45	354	310	356	76	323	248
297	25	374	350	327	46	353	308	357	77	322	246
298	26	373	348	328	47	352	306	358	78	321	244
299	27	372	346	329	48	351	304	359	79	320	242



Y	start_X	end_X	Total	Y	start_X	end_X	Total	Y	start_X	end_X	Total
360	81	318	238	390	139	260	122				
361	82	317	236	391	143	256	114				
362	84	315	232	392	146	253	108				
363	85	314	230	393	150	249	100				
364	86	313	228	394	154	245	92				
365	88	311	224	395	158	241	84				
366	89	310	222	396	163	236	74				
367	91	308	218	397	169	230	62				
368	92	307	216	398	176	223	48				
369	94	305	212	399	187	212	26				
370	96	303	208								
371	97	302	206								
372	99	300	202								
373	101	298	198								
374	102	297	196								
375	104	295	192								
376	106	293	188								
377	108	291	184								
378	110	289	180								
379	112	287	176								
380	114	285	172								
381	116	283	168								
382	118	281	164								
383	121	278	158								
384	123	276	154								
385	125	274	150								
386	128	271	144								
387	131	268	138								
388	133	266	134								
389	136	263	128								



F. Optical Specifications

Item	Abbr.	Min.	Typ.	Max.	Unit	Remark	
Optical Characteristic	Brightness	270	300	--	nits	Note 3	
Contrast ratio	@25deg	10000	--	--		Note 4	
Brightness Uniformity	300nits	85	--	--		Note 5	
Viewing angle CR>1600	Top	80°	--	--	deg	Note 6	
	Bottom	80°	--	--	deg		
	Left	80°	--	--	deg		
	Right	80°	--	--	deg		
Color	White	CIE1931 x	0.28	0.30	0.32	Note 7	
	White	CIE1931 y	0.29	0.31	0.33		
	Red	CIE1931 x	0.645	0.675	0.705		
	Red	CIE1931 y	0.295	0.325	0.355		
	Green	CIE1931 x	0.186	0.236	0.286		
	Green	CIE1931 y	0.661	0.711	0.761		
	Blue	CIE1931 x	0.090	0.130	0.170		
	Blue	CIE1931 y	0.025	0.065	0.105		
NTSC		CIE x , y	82	100	--	%	
Life time	LT95	25°C	150	--	--	hrs	Note 8
Crosstalk	L128△CT	Vertical	--	--	110	%	Note 9
Flicker			--	--	-30	db	Note 10
Optical Switching Time	+25°B/W(Tr+Tf)/2		--	--	1	ms	Note 11
Gamma	γ	1.9	2.2	2.5		Note 12	



Note 1: Ambient temperature =25 °C±2 °C, measured by CA-310

Note 2: To be measured in the dark room.

Note 3: The brightness measurement shall be done at the center of the display with a full white image.

Note 4: Definition of contrast ratio:

Contrast ratio is calculated with the following formula:

$$\text{Contrast ratio (CR)} = \frac{\text{Photo detector output when OLED is at "White" state}}{\text{Photo detector output when OLED is at "Black"}}$$

Note 5: Uniformity. Refer to figure as below

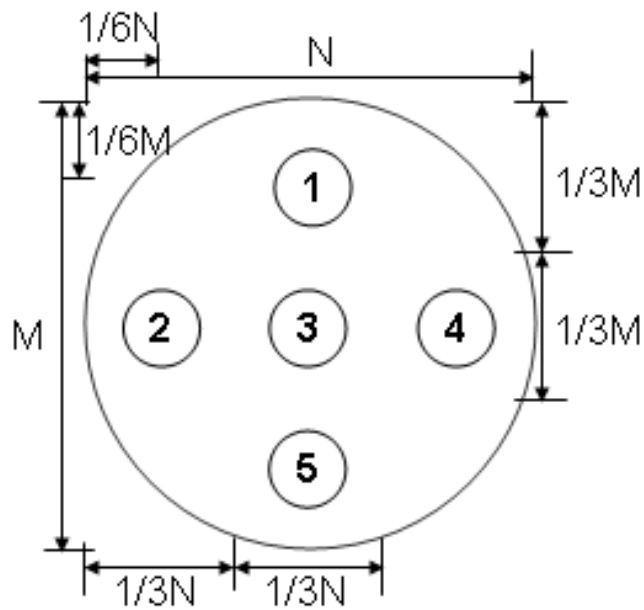

- $\Delta B_p = B_p (\text{Min.}) / B_p (\text{Max.}) \times 100 (\%)$
- $B_p (\text{Max.})$ = Maximum brightness in 5 measured spots
- $B_p (\text{Min.})$ = Minimum brightness in 5 measured spots.

Note 6: Definition of viewing angle :

The optical performance is specified as the driver IC located at =270°



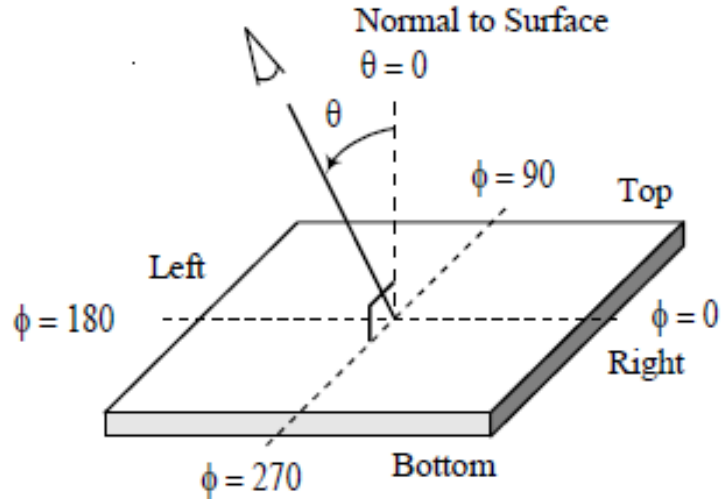

Note 7: The color chromaticity should be based on sample performance because new OLED material should be verified later.

Note 8: Time to 95% Luminance

To measure the burn-in effect, a test pattern with white background applied to the AMOLED display at 100% loading

Note 9: Cross-talk

- There should be no visible cross-talk in normal direction of the display when the two "Cross-talk Test Patterns " below are loaded.
- Measurement equipment: DMS-803 or similar equipments
- The point should be marked is, the background of Cross-talk Test Pattern-"gray " are defined as middle gray scale . For example, RGB 24bit "gray" defined as below:

R7	R6	R5	R4	R3	R2	R1	R0	G7	G6	G5	G4	G3	G2	G1	G0	B7	B6	B5	B4	B3	B2	B1	B0
1	0	0	0	0	0	0	0	1	0	0	0	0	0	0	0	1	0	0	0	0	0	0	0

- $\Delta B_{pn} = B_{pn}(\text{gray}) / B_{pn}(\text{white})$
Which n means the dot No. In the Cross-talk Test Pattern ;
B_{pn} (gray) means the brightness of the No.n spots in Cross-talk Test Pattern A and B;
B_{pn} (white) means the brightness of the No.n spots in Full white Test Pattern;
- $\Delta B_p(\text{Max.}) = \text{Maximum value in A1~A4 and B1~B4.}$
- $\Delta B_p(\text{Min.}) = \text{Minimum value in A1~A4 and pB1~B4.}$
- $\Delta CT = \Delta B_p(\text{Max.}) / \Delta B_p(\text{Min.}).$
- ΔCT must be less than 1.10



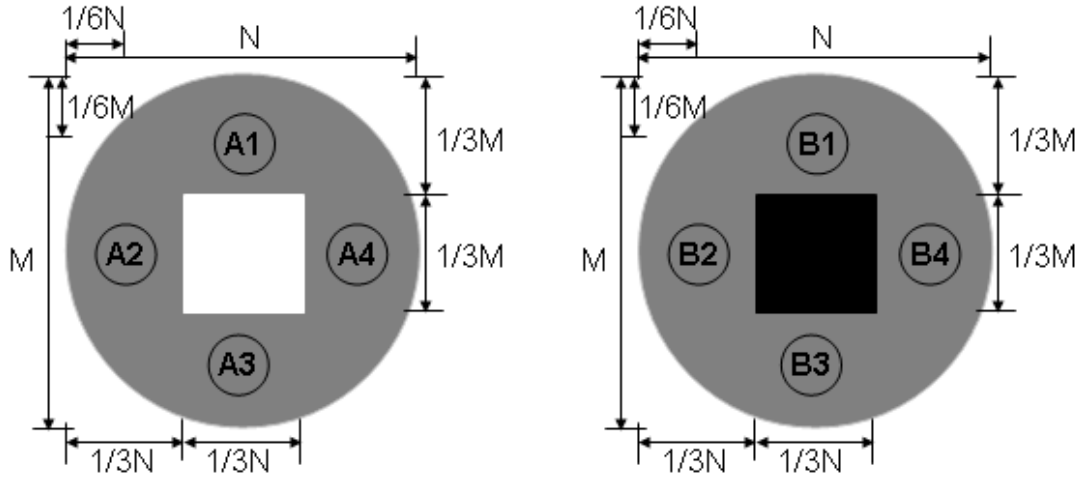

Note 10: Flicker

The flicker level is defined using Fast Fourier Transformation (FTT) as follows:

$$Flicker = 20 \log_{10} \left(2 \frac{f_{FFTC}(n)}{f_{FFTC}(0)} \right) + FS(Hz) \quad (dB)$$

where $f_{FFTC}(n)$ is the nth FFT coefficient, and $f_{FFTC}(0)$ is the 0th FFT coefficient which is DC component. $FS(Hz)$ is the flicker sensitivity as a function of frequency.

The flicker level shall be measured with the test pattern in below.

The gray leves of test pattern is 128.

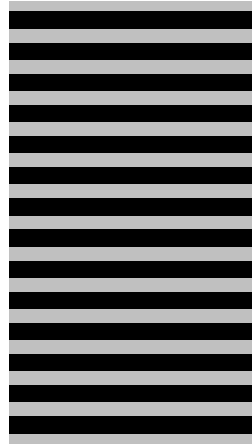

Note 11: Optical Switching Time:

The optical switching time measurements should be performed at driven BLACK and driven WHITE at typ. brightness setting by the driving techniques specified. The luminance should be measured with the emitting display and the detector at $\theta=0^\circ$ and $\psi=90^\circ$. The rise time t_r is the time between a 10% optically response of the display and a 90% optically response of the display. The fall time t_f is the time between a 10% optically response of the display and a 90% optically response to the display. The response time is defined as the average of the rise time and the fall time.



H. Packing

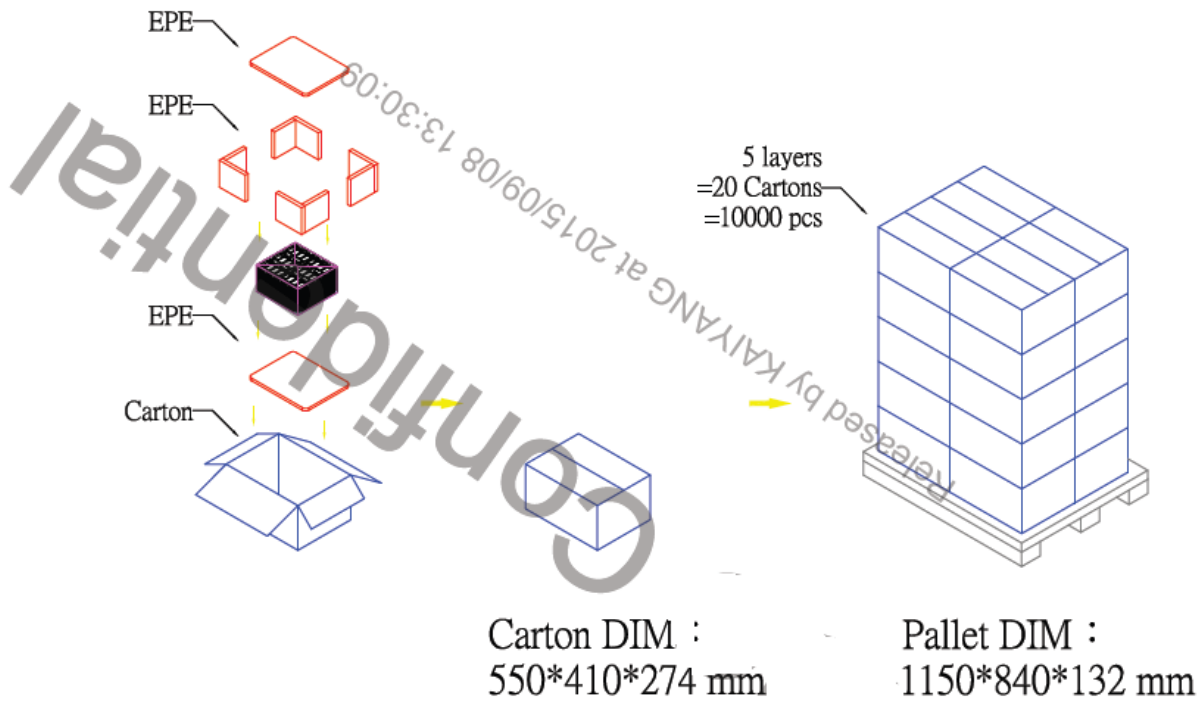
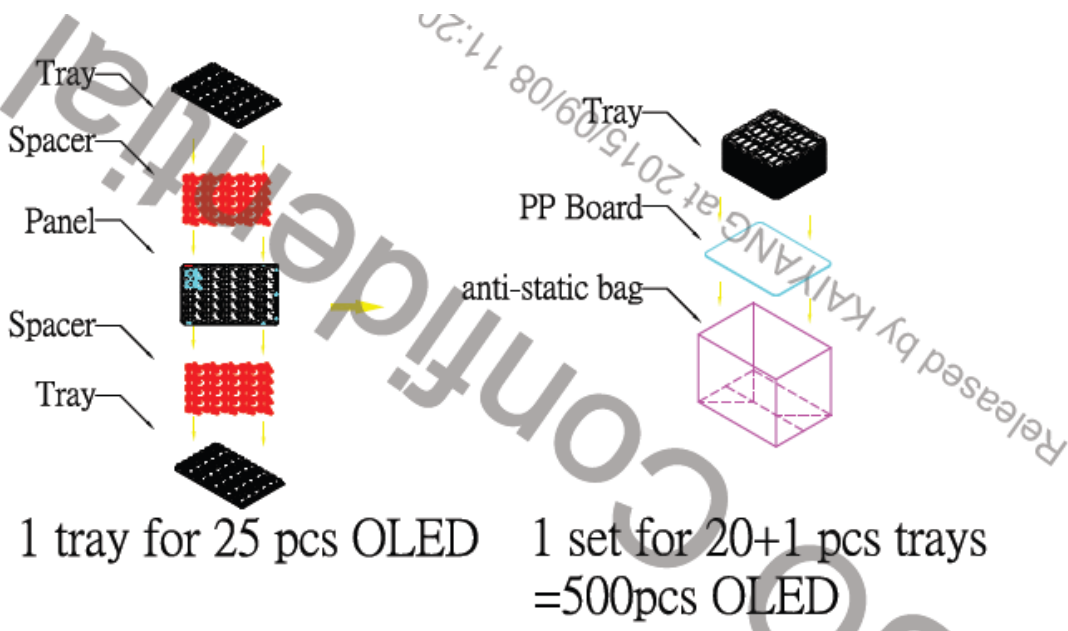

I. Outline Demension

